

BLANCO

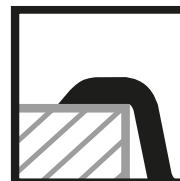

BLANCO GmbH + Co KG
Technischer Kundendienst
Tel.: +49 7045 44-81 419
info@blanco.de · www.blanco.de

BLANCO

225359 09/2011

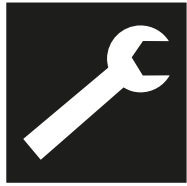
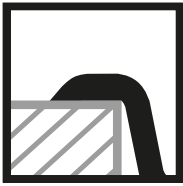

✓ OK
 ✗ not OK

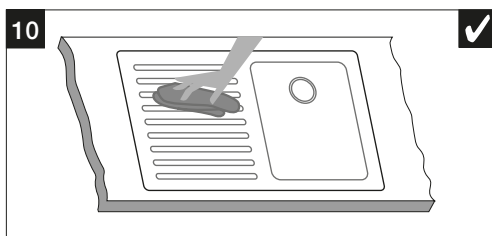
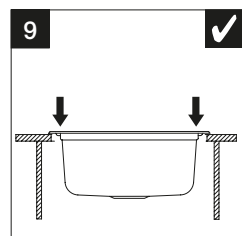
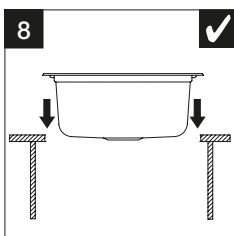
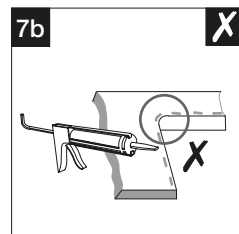
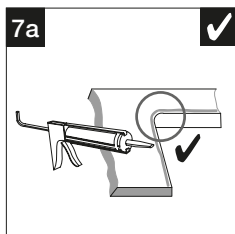
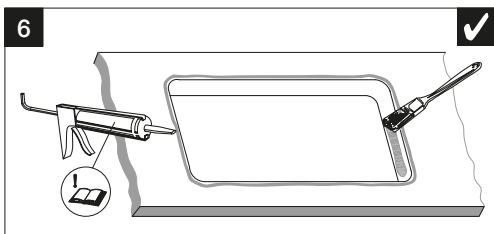
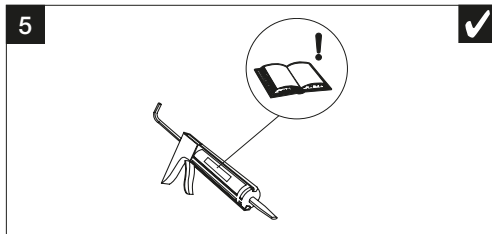
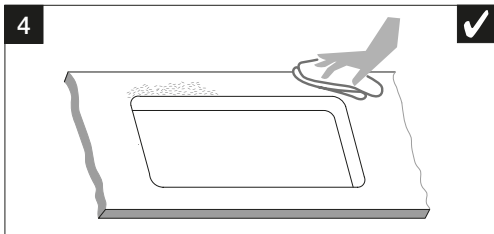
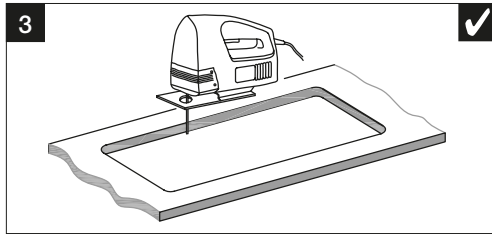
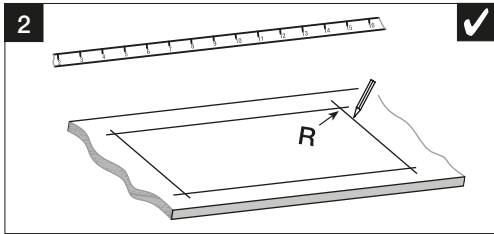
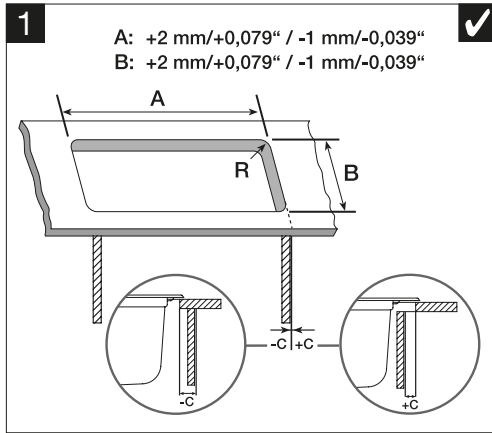
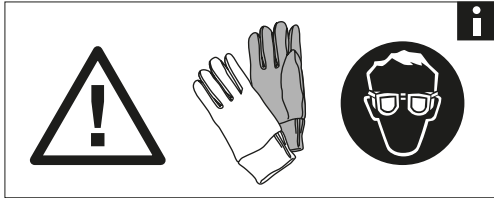

| | +2 mm/+0,079" / -1 mm/-0,039" | | | | C (mm/inch) | | R (mm/inch) | |
|--------------------|-------------------------------|---------|-------------|---------|-------------|---------|-------------|--------|
| | A (mm/inch) | | B (mm/inch) | | | | | |
| BLANCOAXON II 6 S | 977 mm | 38.465" | 488 mm | 19.213" | +6 mm | +0.236" | 15 mm | 0.591" |
| BLANCOIDESSA 45 S | 758 mm | 29.843" | 478 mm | 18.819" | -7 mm | -0.276" | 15 mm | 0.591" |
| BLANCOIDESSA 5 S | 892 mm | 35.118" | 478 mm | 18.819" | -4 mm | -0.157" | 15 mm | 0.591" |
| BLANCOIDESSA 6 S | 977 mm | 38.465" | 478 mm | 18.819" | -6 mm | -0.236" | 15 mm | 0.591" |
| BLANCOIDESSA 8 S | 1140 mm | 44.882" | 480 mm | 18.898" | -5 mm | -0.197" | 15 mm | 0.591" |
| BLANCOIDESSA 9 | 840 mm | 33.071" | 480 mm | 18.898" | -30 mm | -1.181" | 15 mm | 0.591" |
| BLANCOPRION 45 S | 758 mm | 29.843" | 488 mm | 19.213" | -4 mm | -0.157" | 5 mm | 0,197" |
| BLANCOPRION 5 S | 892 mm | 35.118" | 488 mm | 19.213" | -8 mm | -0.315" | 5 mm | 0,197" |
| BLANCOPRION 6 S | 977 mm | 38.465" | 488 mm | 19.213" | -8 mm | -0.315" | 5 mm | 0,197" |
| BLANCOSETURA 5 S | 810 mm | 31,890" | 460 mm | 18,110" | -20 mm | -0,787" | 15 mm | 0.591" |
| BLANCOSETURA 6 S | 950 mm | 37,402" | 460 mm | 18,110" | -12 mm | -0,472" | 15 mm | 0.591" |
| BLANCOZENAR 45 S | 837 mm | 32.953" | 488 mm | 19.213" | -5 mm | -0.197" | 15 mm | 0,591" |
| BLANCOZENAR XL 6 S | 977 mm | 38.465" | 488 mm | 19.213" | -19 mm | -0.748" | 15 mm | 0,591" |